

OVEN 100 SERIES 24"



CODE ID

24" MULTIFUNCTION EASY-CLEAN OVEN

F1SM24S3



Convection



Multi-level cooking



Cool Touch Door



Interior Lighting

SPECIFICATIONS

OVEN

Knob and electronic controls
True Convection
Black Porcelain enamel interior
1 Halogen light
Total capacity 66,8 lt
Total capacity 2,36 cu. ft.
2 chrome racks
Enameled Broiler Pan

OVEN FUNCTIONS

Convection Bake
Convection Broil
Convection Roast
Bake
Broil
Lower Conv. Bake

OPTIONAL ACCESSORIES

FMTELG

Telescopic guides



This product meets ADA (Americans with Disabilities Act) requirements. Please check with your local municipality's codes and stipulations for additional details to ensure compliance.

DISTINTO

24" MULTIFUNCTION EASY-CLEAN OVEN

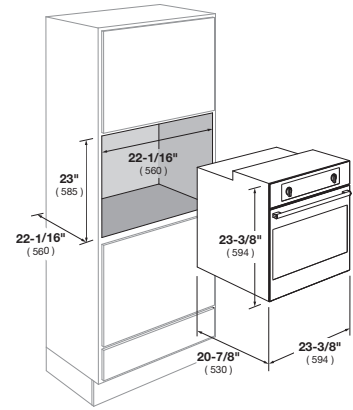

CODE ID	24" MULTIFUNCTION EASY-CLEAN OVEN F1SM24S3	
Series	100	
Finish	Stainless Steel	
CONTROL PANEL		
Control Type	2 Knobs / 3 Touch Buttons	
Display: Clock - Timer	White LED	
OVEN		
Type	Electronic	
Temperature Regulation	Electro-Mechanical Control (min/max 120/480°F - 50/250°C)	
OVEN FUNCTIONS		
	Convection	Bake
	Convection Bake	Oven Lights
	Convection Broil	Broil
	Convection Roast	
OVEN DOOR(S)		
Oven Glass Window	Large See Through Glass	
Door Cooling System	3 Heat Resistant Glasses	
Door Hinges	Heavy Duty Steady Tilt	
Handle Style	Tubular Steel	
OVEN CAVITY		
Total Capacity (lt)	68,8	
Total Capacity (cu. ft.)	2,36	
Cavity Enamel Color	Black	
Rack Positions	5	
Oven Lights	1x20W Halogen	
HEATING ELEMENTS (@240V)		
Broil Upper Heating Element	1200 W	
Upper Auxiliary Element	1000 W	
Lower Auxiliary Element	-	
Concealed Bake Lower Heating Element	1100 W	
Convection Element	2300 W	
OVEN ACCESSORIES		
Chrome Racks	2	
Enameled Broiler Pan	1	
Telescopic Chrome Rack	Optional	
DIMENSIONS/WEIGHT		
Overall dim - Width	23 - 3/8"	594 mm
Overall dim - Height	23 - 3/8"	594 mm
Overall dim - Depth	21 - 7/8"	556 mm
Cut-out - Width	22 - 1/16"	560 mm
Cut-out - Height (min)	23"	585 mm
Cut-out - Depth (min)	22 - 1/16"	560 mm
Gross Weight	90 lbs	41 kg
POWER / RATINGS (208/240 V, 60 HZ)		
kW / Amps rating at 120-240V, 60Hz	2.35kW - 9.8A	
kW / Amps rating at 120-208V, 60Hz	1.80kW - 8.6A	
Power Cable	Conduit	
INSTRUCTIONS FOR USE		
Use & Care Manual / Installation Manual	English / French / Spanish	