

# OVEN 700 SERIES 30"













CODE ID

30" TOUCH CONTROL DOUBLE OVEN - WHITE GLASS

**F7DP30W1**



-  **CREACTIVE COOKING SYSTEM**
-  **PIZZA COOKING MODE 590 °F**
-  Dual Convection
-  Self Clean Oven
-  Multi-level cooking
-  1 Telescopic Rack
-  Cool Touch Door
-  TFT Display
-  Meat Probe
-  Fast Pre-Heat
-  Interior Lighting

## OVENS

Creative Touch Control System  
Dual True Convection  
Self-cleaning oven with Multifunction baking  
Black Porcelain enamel interior  
Cool to the touch  
Extra-large baking cavity and viewing area  
3 Halogen lights for flawless visibility  
Gross capacity 4.4 cu. ft.  
2 chromed racks  
1 telescopic rack per oven  
Enameled Broiler Pan  
Lock Keys  
Door Lock

## OVEN FUNCTIONS

Bake (cooking group)  
Broil  
Convection (cooking group)  
Keep Warm (cooking group)  
Recipes  
Classic Pizza Function 590°F  
Preset default temperature  
Preheat (display instantaneous temperature)  
Fast Preheat Mode  
Sabbath Mode  
Setting Temperature °C/°F  
Setting Weight Kg/lb  
Event Logs (for Service)  
Meat Probe (only upper oven)  
Self-Clean

## OPTIONAL ACCESSORIES

FMTR630      30" Telesc. Rack

# SOFIA

30" TOUCH CONTROL DOUBLE OVEN



**F7DP30S1**  
Stainless Steel



**F7DP30B1**  
Black Glass



**F7DP30W1**  
White Glass

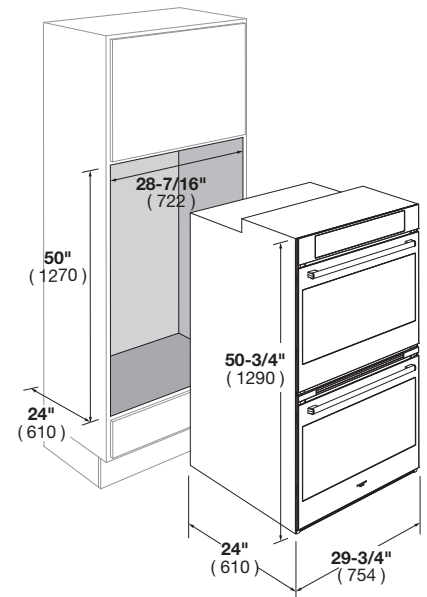

CODE ID	F7DP30S1 30" TOUCH CONTROL DOUBLE OVEN	F7DP30B1 30" TOUCH CONTROL DOUBLE OVEN	F7DP30W1 30" TOUCH CONTROL DOUBLE OVEN
Series and Finish	700 Series - Stainless Steel	700 Series - Black Glass	700 Series - White Glass
<b>CONTROL PANEL</b>	Creative Electronic Touch Control		
Control Type	TFT 3.5"		
Display: Clock - Temperature - Function	English (USA) / English (UK) / French / Spanish / Italian / German		
Language	Control Interface	Chime Volume Setting	
	Full Touch: Functions - Recipes	Date Format	
	Settings Menu - Brightness Setting	Demo Mode	
<b>OVEN</b>	Dual True Convection		
Type	Electronic Control (min/max 170/550°F - 75/290°C)		
Temperature Regulation			
<b>OVEN FUNCTIONS</b>	Pyrolytic Self-Clean	Broil	
	True Convection	Dehydrate	
	Convection Broil	Thaw (Defrost)	
	Convection Roast	Proof (Warm)	
	Pizza (Lower Convection)	Keep warm (Warm Plus)	
	Bake	Oven Lights	
<b>ELECTRIC OVEN FEATURES</b>	Preset default temperature	Display instantaneous temperature	
	Child Door Lock	Control Display Lock	
	Sabbath Mode	12/24 Hour Clock Formats	
	Automatic Fast Preheat	Display	
	Meat Probe (Upper Oven Only)	Event Logs (for Service)	
<b>OVEN DOOR(S)</b>	Large See Through Glass		
Oven Glass Window	4 Heat Resistant Glasses		
Door Cooling System	Heavy Duty Steady Tilt		
Door Hinges			
<b>OVEN CAVITY</b>	Gross Capacity (cbft) 4.4		
Gross Capacity (cbft)	Usable Capacity (cbft) 4.1		
Usable Capacity (cbft)	Cavity Enamel Colour Black		
Cavity Enamel Colour	6 Rack Positions		
Rack Positions	3x20W Halogen Oven Lights		
Oven Lights			
<b>HEATING ELEMENTS (@240V)</b>	Broil Upper Heating Element 3500 W		
Broil Upper Heating Element	Upper Auxiliary Element 1032 W		
Upper Auxiliary Element	Concealed Bake Lower Heating Element 3000 W		
Concealed Bake Lower Heating Element	Convection Element 2 x 1300 W		
Convection Element			
<b>OVEN ACCESSORIES</b>	2 Chromed Racks		
Chromed Racks	1 Enameled Broiler Pan (basin + anti splash)		
Enameled Broiler Pan (basin + anti splash)	1 Telescopic Chromed Rack		
Telescopic Chromed Rack			
<b>DIMENSIONS/WEIGHT</b>	Overall dim - Width 29 - 11/16" (754 mm)		
Overall dim - Width	Overall dim - Height 50 - 13/16" (1290 mm)		
Overall dim - Height	Overall dim - Depth 24" (610 mm)		
Overall dim - Depth	Cut-out - Width 28 - 7/16" (722 mm)		
Cut-out - Width	Cut-out - Height (min) 50" (1270 mm)		
Cut-out - Height (min)	Cut-out - Depth (min) 23 - 1/4" (590 mm)		
Cut-out - Depth (min)	Gross Weight 326 lbs (148 kg)		
Gross Weight			
<b>POWER / RATINGS (208/240 V, 60 HZ)</b>	kW / Amps rating at 120-240V, 60Hz 7.50kW - 31.2A		
kW / Amps rating at 120-240V, 60Hz	kW / Amps rating at 120-208V, 60Hz 6.30kW - 30.3A		
kW / Amps rating at 120-208V, 60Hz	Power Cable Conduit		
Power Cable			
<b>INSTRUCTIONS FOR USE</b>	Use & Care Manual / Installation Manual English / French / Spanish		
Use & Care Manual / Installation Manual			