

OVEN 700 SERIES 30"













CODE ID

30" TOUCH CONTROL SINGLE OVEN - WHITE GLASS

F7SP30W1



-  CREACTIVE COOKING SYSTEM
-  PIZZA COOKING MODE 590 °F
-  Dual Convection
-  Self Clean Oven
-  Multi-level cooking
-  1 Telescopic Rack
-  Cool Touch Door
-  TFT Display
-  Meat Probe
-  Fast Pre-Heat
-  Interior Lighting

OVEN

Creative Touch Control System
Dual True Convection
Self-cleaning oven with Multifunction baking
Black Porcelain enamel interior
Cool to the touch
Extra-large baking cavity and viewing area
3 Halogen lights for flawless visibility
Gross capacity 4.4 cu. ft.
2 chromed racks
1 telescopic rack
Enameled Broiler Pan
Lock Keys
Door Lock

OVEN FUNCTIONS

Bake (cooking group)
Broil
Convection (cooking group)
Keep Warm (cooking group)
Recipes
Classic Pizza Function 590°F
Preset default temperature
Preheat (display instantaneous temperature)
Fast Preheat Mode
Sabbath Mode
Setting Temperature °C/°F
Setting Weight Kg/lb
Event Logs (for Service)
Meat Probe
Self-Clean

OPTIONAL ACCESSORIES

FMTR630 30" Telesc. Rack

DISTINTO

30" TOUCH CONTROL SINGLE OVEN



F7SP30S1
Stainless Steel



F7SP30B1
Black Glass



F7SP30W1
White Glass

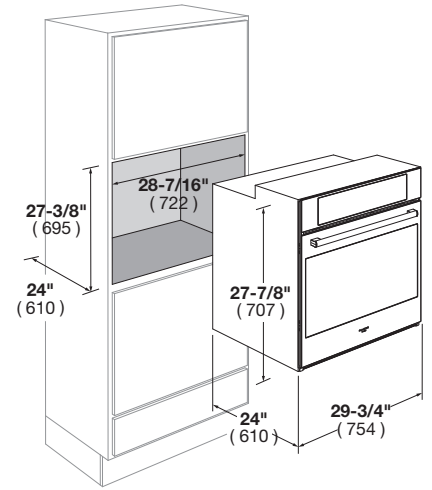

CODE ID	F7SP30S1 30" TOUCH CONTROL DOUBLE OVEN	F7SP30B1 30" TOUCH CONTROL DOUBLE OVEN	F7SP30W1 30" TOUCH CONTROL DOUBLE OVEN
Series and Finish	700 Series - Stainless Steel	700 Series - Black Glass	700 Series - White Glass
CONTROL PANEL	Creative Electronic Touch Control		
Control Type	TFT 3.5"		
Display: Clock - Temperature - Function	English (USA) / English (UK) / French / Spanish / Italian / German		
Language	Control Interface	Chime Volume Setting	
	Full Touch: Functions - Recipes	Date Format	
	Settings Menu - Brightness Setting	Demo Mode	
OVEN	Dual True Convection		
Type	Electronic Control (min/max 170/550°F - 75/290°C)		
Temperature Regulation			
OVEN FUNCTIONS	Pyrolytic Self-Clean	Broil	
	True Convection	Dehydrate	
	Convection Broil	Thaw (Defrost)	
	Convection Roast	Proof (Warm)	
	Pizza (Lower Convection)	Keep warm (Warm Plus)	
	Bake	Oven Lights	
ELECTRIC OVEN FEATURES	Preset default temperature	Display instantaneous temperature	
	Child Door Lock	Control Display Lock	
	Sabbath Mode	12/24 Hour Clock Formats	
	Automatic Fast Preheat	Display	
	Meat Probe (Upper Oven Only)	Event Logs (for Service)	
OVEN DOOR(S)	Large See Through Glass		
Oven Glass Window	4 Heat Resistant Glasses		
Door Cooling System	Heavy Duty Steady Tilt		
Door Hinges			
OVEN CAVITY	4.4		
Gross Capacity (cbft)	4.1		
Usable Capacity (cbft)	Black		
Cavity Enamel Colour	6		
Rack Positions	3x20W Halogen		
Oven Lights			
HEATING ELEMENTS (@240V)	3500 W		
Broil Upper Heating Element	1032 W		
Upper Auxiliary Element	3000 W		
Concealed Bake Lower Heating Element	2 x 1300 W		
Convection Element			
OVEN ACCESSORIES	2		
Chromed Racks	1		
Enameled Broiler Pan (basin + anti splash)	1		
Telescopic Chromed Rack			
DIMENSIONS/WEIGHT	Overall dim - Width	29 - 11/16"	(754 mm)
	Overall dim - Height	27 - 7/8"	(707 mm)
	Overall dim - Depth	24"	(610 mm)
	Cut-out - Width	28 - 7/16"	(722 mm)
	Cut-out - Height (min)	27 - 3/8"	(695 mm)
	Cut-out - Depth (min)	23 - 1/4"	(590 mm)
	Gross Weight	183 lbs	(83 kg)
POWER / RATINGS (208/240 V, 60 HZ)	3.70kW - 15.4A		
kW / Amps rating at 120-240V, 60Hz	3.50kW - 16.8A		
kW / Amps rating at 120-208V, 60Hz	Conduit		
Power Cable			
INSTRUCTIONS FOR USE	English / French / Spanish		
Use & Care Manual / Installation Manual			