

SOFIA PROFESSIONAL 30"









CODE ID

30" PROFESSIONAL COMBI STEAM OVEN

F6PSCO30S1



-  Steam Cooking
-  Steam Limescale Filter
-  True Convection
-  Automatic Cooking
-  Meat Probe
-  Cool Touch Door
-  Multi-level cooking

SPECIFICATIONS

FEATURES

3 in 1 Oven:
Steam, Convection, and Combi-steam
Stainless Interior with broiler
Quick Access Menu
Automatic Programs
Meat Probe
240 Volt Connection
Steam Generator

PERFORMANCE

12 Functions
Automatic Cooking
Pre-selected and customizable recipes
(weight, temperature, cooking time)
Steam System
Combined Cooking Functions
Steam Recovery Cycle
CLEAN, assisted cleaning cycle for
oven interior and steam circuit

SOFIA

PROFESSIONAL COMBI SPEED OVEN

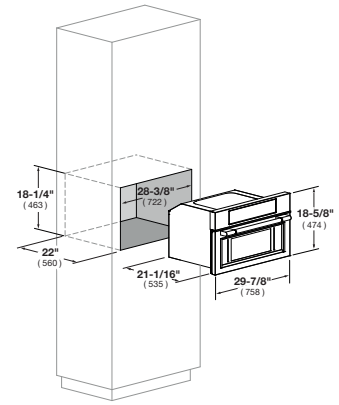

CODE ID		30" SOFIA PRO STEAM OVEN - F6PSCO30S1	
Type	Steam + fan assisted		
Finish	Stainless steel		
Temperature Regulation	Electronic		
FUNCTIONS			
Microwave / Steam cook	-/•		
Steam reheat	•		
Microwave / Steam convection	•		
Steam clean / circuit	•		
5 minute steam	•		
Convection bake	•		
Convection roast	•		
Convection broil	•		
Broil	•		
Eco convection bake	•		
Recipes	•		
Oven Lights	•		
CONTROL PANEL			
Control type	MODULAR - Electronic		
Display	TFT 3.5"		
Menu Recipes	•		
Commands	Dual Full Touch Keyboard		
Language	4		
SPECIAL FEATURES			
Manual Fast Preheat	•		
Meat Probe	•		
12/24 hour clock format	•		
°C/°F	•		
OVEN DOOR(S)			
Cool door	•		
OVEN CAPACITY			
Gross Capacity (cuft)	1.2		
Usable Capacity (cuft)	1.0		
Cavity Enamel Color	Stainless Steel		
Rack Positions	3		
Oven Lights	1x20W Halogen		
Broil Upper Heating Element	1500W (240V)		
Steamer	1500W (240V)		
Lower Element Wattage	300W (240V)		
Convection Element Wattage	2300W (240V)		
ACCESSORIES			
Chrome racks	1		
Stainless Steel Tray	•		
Telescopic chrome rack	-		
SIZE			
Overall dim - width	29 - 7/8"		758 mm
Overall dim - height	18 - 5/8"		473 mm
Overall dim - depth	21"		533 mm
Cutout - width	25 - 3/4"		654 mm
Cutout - height (min)	18"		458 mm
Cutout - depth (min)	22"		560 mm
POWER / RATINGS			
KW/Amps rating at 240V, 60Hz	3.3kW - 13.7A		
KW/Amps rating at 208V, 60Hz	2.48kW - 11.9A		
Cable + Conduit	•		
INSTRUCTION FOR USE			
Use & Care Manual / Installation Manual	EN, SP, FR		