

24" DISHWASHER







CODE ID

24" STAINLESS STEEL BUILT-IN DISHWASHER SHOWN WITH DISTINTO HANDLE KIT

F6DWT24SS2
F7HK24DISHS



-  Noise Level 45 (dB)
-  Steel Tub
-  Fast Wash Cycle
-  1/2 Load Cycle
-  Flexible Rack Loading

NOTE: THE PICTURE ABOVE FEATURES

F6DWT24SS2 Dishwasher
F7HK24DISHS Distinto Handle Kit

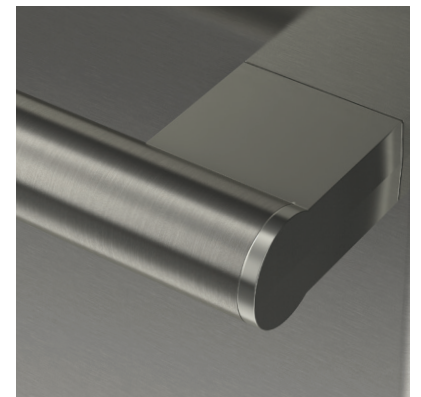

SPECIFICATIONS

16 Place Settings
6 Programs
45 dB Silent Operations
Flexible Rack Loading
All-In-One single tablet Detergent Function
Fast Function
5 Level Wash
Flow-Through Heater
3 way Euro Filtering System
Front Adjustable rear feet
Adjustable Hinge System
Built-in High Loop with Air Gap
Double Motion Float System

REQUIRED ACCESSORIES

F7HK24DISHS
Distinto Dishwasher Handle Kit

DISTINTO

24" BUILT-IN DISHWASHER

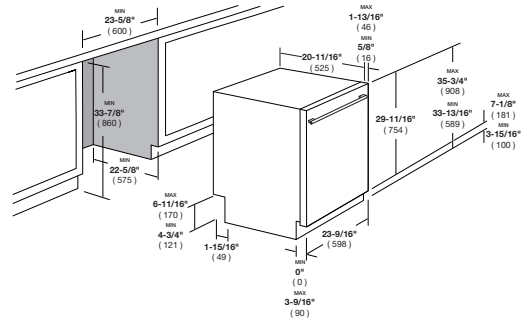

CODE ID	24" STAINLESS STEEL BUILT-IN DISHWASHER + DISTINTO HANDLE KIT F6DWT24SS2 + F7HK24DISHS
Finish	Stainless steel
PERFORMANCES	
Position	Top of door
Type	Electronic
DISPLAY	
Rinse Aid Indicator	LED Icon
LED Spot	Floor Illuminating Led Spotlight
MAIN FEATURES	
Loading Capacity (Place settings)	16
Tub Material	Stainless Steel
Inner Door Material	Stainless Steel
Overflow Protection	•
5 Level Wash	•
Delay Timer	1 -24 Hours
3-way Euro Filter	•
Drying Fan Assisted	Fan Assisted Condensation
Brushless DC™ Motor	•
Turbidity Sensor	•
Silent Operation	45 dB(A)
Interior High Loop with Air Gap	•
Self Clean Cycle	•
FUNCTION	
Half Load Function	•
Sanitize Function	•
RapidClean	•
ExtraRinse	•
PROGRAMS	
Number of Programs	6
Pots and Pans+ (167° F rinse temp.)	•
MixWash+ (142 - 145° F rinse temp.)	•
Regular Wash (142 - 145° F rinse temp.)	•
Daily Wash	•
Quick Wash (131° F)	•
Rinse & Hold	•
TECHNICAL FEATURES	
Permissible Water Pressure	4.35 - 145 psi (0.3 - 10 bars)
Electrical Connection	120 V, 12 A, 60Hz
Total Power	1400 W (watts)
Heater Power	1100 W (watts)
RACK SYSTEM	
Cutlery Basket	Sliding
Upper Rack (Inset Shelves)	2
Adjustable Upper Rack	Able to raise/lower the rack when fully loaded
3rd Rack	Full-width
ENVIRONMENTAL	
ENERGY STAR® Qualified	•
Energy Consumption, Wh/year	255
Water Consumption gal/cycle	3.5 - 5.0
RoHS compliant (Lead Free)	•
DIMENSION/WEIGHT	
H x W x D, in.	33 - 7/8" x 23 - 9/16" x 22 - 1/2"
H x W x D, cm	86.1 x 59.8 x 57
Product Weights, lbs	154 lbs
Product Weights, kg	70 kg
INSTRUCTIONS FOR USE	
Use & Care Manual / Installation Manual	English / Spanish / French