

CLUSTER CONCEPT COMBISET











CODE ID

COFFEE MACHINE 45

FCLCM 4500 TF BK



-  Touch Control
-  LED Lighting
-  Boiling Water
-  Automatic Coffee Grinder
-  Cappuccino Maker
-  Automatic Cleaning
-  Push Opening
-  TFT Display

COFFEE MACHINE FEATURES

Obsidian black glass
TFT Display
Coffee Bean Grinder
Coffee Bean Container (200 g)
1.8 L Water tank
Ground Coffee Container
Removable dispenser for boiling water,
for hot milk and for cappuccino
Steam dispenser
Liquid collection basin
Opening with telescopic guides

PERFORMANCE

30 Automatic programs
3 Coffee temperatures
Alternating contemporary preparation,
2 cups for 5 types of coffee:
Extra strong, strong, medium, light,
very light
5 types of cups: Espresso, short coffee,
medium, large, jug
Cappuccino maker
Steam delivery
Hot water supply (tea, infusions, herbal teas)
Stand-by (energy saving)

SAFETY

Water hardness setting
Coffee and water refill indicators
Cleaning indicator
Limescale filter indicator

INCLUDED ACCESSORIES

Milk Container
Telescopic racks
Power cord with plug

MATCH WITH

Standard Drawer FCLD 150 BK



OBSIDIAN BLACK GLASS
FCLCM 4500 TF BK

CLUSTER CONCEPT

COFFEE MACHINE

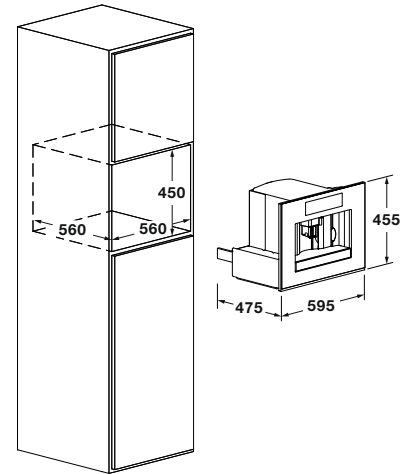

FCLCM 4500 TF BK	
Type	Coffee Machine
Finishing	Obsidian black glass
PERFORMANCE	
Functions nr.	30
Automatic functions	Coffee, Steam, Hot Water
Programming	Touch TFT
Energy efficiency class	A
Yearly power consumption kWh	45
Water tank capacity	1,8 l.
Coffee container capacity	200 gr.
Coffee grinder with 13 levels regulations	•
Coffee cups nr.	2
Coffee dispenser height regulation from 80 to 100 mm	•
Retractable steam dispenser	•
Led lighting	•
Limestone automatic filter	•
Automatic cleaning program	•
Milk container 0,75 Lt.	•
Drip tray	•
Limestone warning light	•
Emptying coffee residues warning light	•
Water tank refill warning light	•
POWER RATING	
Max absorbed power (W)	1350 W
Tension and frequency (V-Hz)	220 - 240 / 50 - 60
Cord	•
Plug Type	Schuko
Pump pressure (bar)	15
DIMENSIONS	
Width mm	595
Height mm	455
Depth mm	475
Cut-out (W x H x D) mm	560 x 450 x 560