











-  Pyrolytic
-  Multi-level cooking
-  Energy class
-  Sliding telescopic rails
-  Cool touch door
-  Interior lighting
-  Digital display
-  Soft Closing

MULTIFUNCTION SELF CLEANING ELECTRONIC OVEN

Self-cleaning
Energy class: A +
Soft Closing
Matte black metal finish

PERFORMANCE

10 functions
Pyrolytic self-cleaning

FEATURES

Digit Control and metal soft knobs
UltraBlack enameled interior (nickel-free)
2-point alogen interior lighting
Gross capacity 65 liters

SAFETY

Cool touch door (50°C)
Oven door with automatic safety lock during the self-cleaning cycle
Control panel with safety key
Tangential cooling ventilation

INCLUDED ACCESSORIES

1 enamelled tray
2 flat metal racks
Telescopic rails set
Power cord with plug



MATTE BLACK METAL
FUO 6011 P MT MBK

URBANTECH

MULTIFUNCTION OVEN

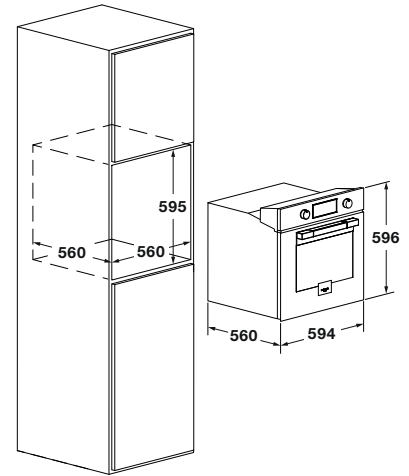

FUO 6011 P MT MBK	
Type	Self cleaning multifunction
Finishing	Matte black metal
Inner sleeve	Ultra Black Piro
FEATURES	
Energy efficiency class	A +
Usable capacity (litres)	65 L
Cooling	•
Functions n.	10
PERFORMANCE	
Cooking max. temperature	250° C
Pyrolysis Temperature	465° C
Self-cleaning by Pyrolysis /Eco Pyrolysis	• / -
Assisted cleaning (CLEAN)	-
CONTROLS	
Programming	Digit Control with knobs
Recipes	-
Auto switch off	•
Booster	-
Meat probe	-
Internal lighting	•
SAFETY	
Safety lock door (during pyrolysis)	•
Cold door / glass nr.	• / 4
ACCESSORIES	
Lighting (20W Halogen lamps) nr.	2
Telescopic rails n.	1
Trays nr./ type	1 / enamelled
Flat metal rack n.	2
POWER RATING	
Max absorbed power (W)	3350 W
Tension and frequency (V - Hz)	220 - 40 / 50 - 60
Power cord	•
Plug	Schuko
DIMENSIONS	
Width mm	594
Height mm	596
Depth mm	560
Cut-out (W x H x D) mm	560 x 595 x 560