









MULTIFUNCTION ELECTRONIC OVEN 60

FUO 6009 MT MBK

-  True convection
-  Sliding telescopic rails
-  Digital display
-  Interior lighting
-  Energy class
-  Soft Closing

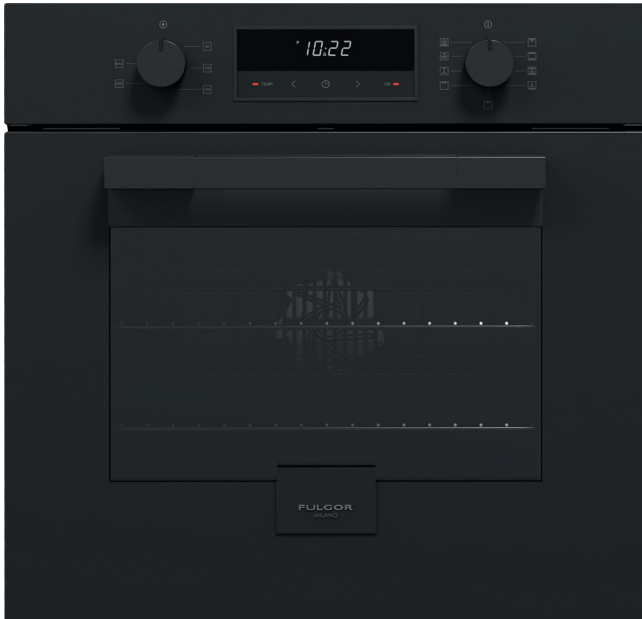

MULTIFUNCTION ELECTRONIC OVEN

Energy class: A
Soft Closing
Matte black metal finish

PERFORMANCE

9 functions
True convection

FEATURES

Digit Timer and metal soft knobs
UltraBlack enameled interior (nickel-free)
Interior lighting
Gross capacity 65 liters

SAFETY

Safe door (3 ipotermic glass)
Tangential cooling ventilation

INCLUDED ACCESSORIES

1 enamelled tray
2 flat metal racks
Telescopic rails set
Power cord with plug



MATTE BLACK METAL
FUO 6009 MT MBK

URBANTECH

MULTIFUNCTION OVEN

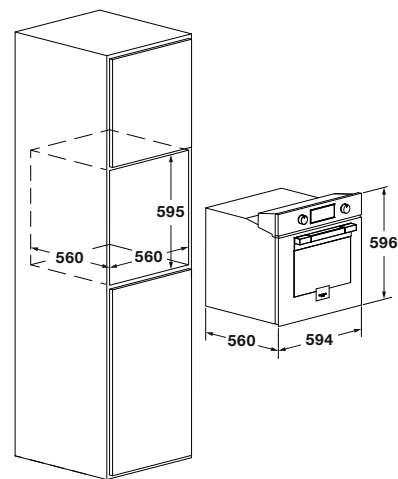

FUO 6009 MT MBK	
Type	Multifunction
Finishing	Matte black metal
Inner sleeve	Ultra Black Piro
FEATURES	
Energy efficiency class	A
Usable capacity (litres)	65 L
Cooling	•
Functions n.	9
PERFORMANCE	
Cooking max. temperature	250° C
Pyrolysis Temperature	-
Self-cleaning by Pyrolysis /Eco Pyrolysis	-
Assisted cleaning (CLEAN)	•
CONTROLS	
Programming	Digit Timer with knobs
Recipes	-
Auto switch off	•
Booster	-
Meat probe	-
Internal lighting	•
SAFETY	
Safety lock door (during pyrolysis)	-
Cold door / glass nr.	• / 3
ACCESSORIES	
Lighting (20W Halogen lamps) nr.	1
Telescopic rails n.	1
Trays nr./ type	1 / enamelled
Flat metal rack n.	2
POWER RATING	
Max absorbed power (W)	3500 W
Tension and frequency (V - Hz)	220 - 40 / 50 - 60
Power cord	•
Plug	Schuko
DIMENSIONS	
Width mm	594
Height mm	596
Depth mm	560
Cut-out (W x H x D) mm	560 x 595 x 560