

DISTINTO MICROWAVE OVEN 24"









CODE ID

24" COUNTER-TOP MICROWAVE

F4MWO24S1



-  Sensor Cooking
-  Power Selection
-  Touch Controls
-  Presets
-  1100 Watts
-  Auto Defrost
-  Child Safety Lock

NOTE

F4TK30MWO Trim Kit - for a built-in installation, 30" trim kit may be purchased separately

SPECIFICATIONS

Family Size
11 Power Levels
No Handle - Push Button Open
Electronic Touch Control
Super Defrost
Sensor Cook Menu
Audible Signal Elimination
Auto Start
Child Lock
Extra Minute
4 Program Stages

DISTINTO

24" COUNTER-TOP MICROWAVE

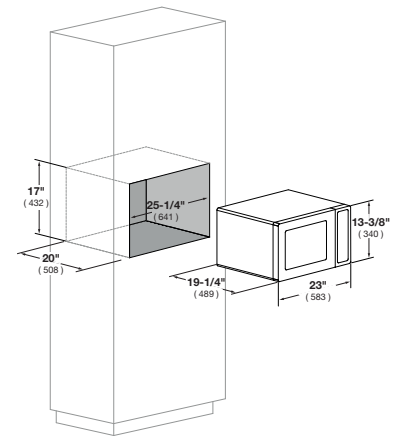

CODE ID	24" COUNTER-TOP MICROWAVE F4MWO24S1
Handle	No Handle - Push Button Open
Installation	CounterTop or with Trim Kit
Finish	Stainless Steel
CONTROL PANEL	
Control System	Electronic - Touch Control
Display & Digital Clock	2 Lines LCD - Segment Style
Color	White Fonts on Black Background
CAPACITIES	
Cavity Size (cu.ft)	2.0
FEATURES	
Power Selection	11 levels
Sensor Cook Menu	11 (Baked Pototates, Fish Seafood, Fresh Vegetables, Frozen Entrees, Frozen Snacks, Frozen Vegetables, Ground Meat, Rice, Sensor Reheat, Popcorn, Poultry)
Breakfast Menu	5 (Scrambled Eggs, Bacon, Hot Cereal, Heat Rolls/Muffins, Frozen Breakfast Foods)
Lunch Menu	5 (Meal in a Cup, Hot Dogs in Buns, Soup, Microwave Pizza, Frozen Sandwich)
Dinner Menu	5 (Saucy Chicken, Hawaiian Pork, Fiesta Chili, Glazed Salmon, Healthy Frittata)
Quick Recipes	5 (Beef Wraps, Mexican Chicken, Italian Salad, Tuna Macaroni, Garden Medley)
Defrost	4 (Steaks Chops or Fish, Chicken Pieces, Roast, Casserole/Soup)
(Super) Defrost	3 (Ground Meat, Boneless Poultry, Bone-in Chicken Pieces)
Beverage	2 (to make Coffee or Tea, to sensor Reheat Beverage)
Help Menu	5 (Child Lock, Audible Signal Elimination, Auto Start, Language / Weight Selection, Clock On/Off)
Oven Light	1 Incandescent
TECHNICAL FEATURES	
Supply Voltage, V/Hz	120V/ 60Hz
Rated Current, A	2.2 A
DIMENSIONS	
Cavity Dimension (WxDxH)	17 - 3/8" x 18 - 5/8" x 10 - 1/4"
Exterior Dimension (WxD*H)	23 - 15/16" x 19 - 1/4" x 13 - 3/8"
Net Weight / Gross Weight	51.1 lbs / 64.1 lbs
INSTRUCTIONS FOR USE	
Use & Care Manual / Installation Manual	English / French