

30" INDUCTION COOKTOP

400 SERIES



CODE ID

F4IT30S2

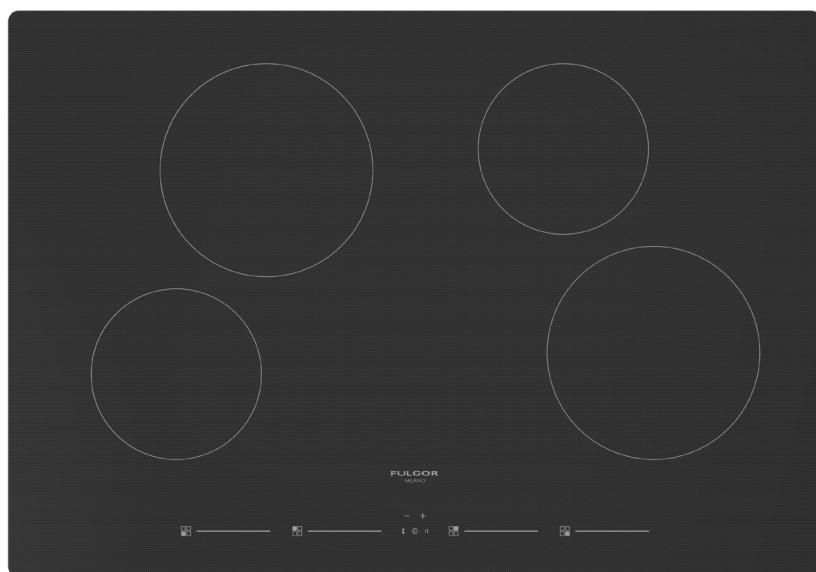

Easy Clean Ceramic Glass



Slide Touch Control



Pan Detection system



Residual Heat Sensor



Digital Minute Minder

INDUCTION COOKTOP

4 Induction cooking zones

Slide touch control for power setting

Elegant Ceramic glass surface

Premium induction technology

for unsurpassed performance

Melt Function

Residual heat and Power on Indicators

Digital Minute Minder

Pot Detection System

Child Lock Function

Independent timer for each zone

Pause function

Booster function for each cooking zone

Failure Codes Indication

Digital Display for Power Level

Automatic Heat-up Time

DISTINTO

30" INDUCTION COOKTOP

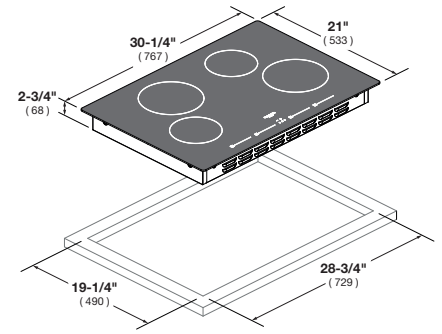
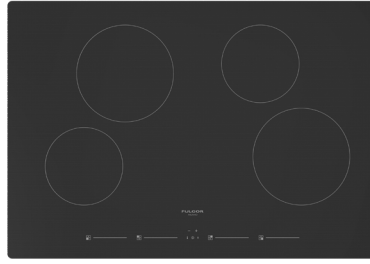

CODE ID	F4IT30S2 - 30" INDUCTION COOKTOP			
Series and Finish	400 Series - Ceramic glass			
CONTROL PANEL				
Control Type	Touch Control			
COOKTOP				
Type	Induction			
Cooking Surface	Ceramic Glass			
INDUCTION COOKTOP FEATURES				
Pot Detection System	•			
Child lock function	•			
Cooling fan system	•			
Failure Codes indication	•			
Slide touch control for power setting	•			
Power levels	1 to 9			
Digital display for power level indication	•			
Led bar for power level indication	•			
Melting Function 113°F / 45°C (inside the pot 108°F / 42°C)	•			
Booster/Fast boil function for each zone	•			
Heat up time automatic function for each zone	•			
Residual heat indication for each zone	•			
Minute minder functions for each zone + one general (Led Indicator)	1+4			
Key Lock (Led Indicator)	•			
Pause/recall (Led Indicator)	•			
General ON/OFF Key (Led Indicator)	•			
Dedicated ON/OFF Key for each zone	•			
Acoustic buzzer	•			
Burners types (Front-L) - Power (Max/Booster)	Inductor	6 - 1/4"	160 mm	1400W / 2100W
Burners types (Front-R) - Power (Max/Booster)	Inductor	7 - 7/8"	200 mm	2300W / 3000W
Burners types (Rear-L) - Power (Max/Booster)	Inductor	7 - 7/8"	200 mm	2300W / 3000W
Burners types (Rear-R) - Power (Max/Booster)	Inductor	6 - 1/4"	160 mm	1400W / 2100W
DIMENSIONS/WEIGHT				
Overall dim - Width	30 - 1/4"		767 mm	
Overall dim - Height (without conduit)	2 - 7/8"		73 mm	
Overall dim - Depth	21"		533 mm	
Cut-out - Width	28 - 3/4"		729 mm	
Cut-out - Height	2 - 3/4"		68 mm	
Cut-out - Depth	19 - 1/4"		490 mm	
Gross Weight	35 lbs		16 kg	
POWER / RATINGS (208/240 V, 60 HZ)				
kW / Amps rating at 240V, 60Hz	7.40kW - 31A			
kW / Amps rating at 208V, 60Hz	6.40kW - 31A			
Power Cable and Conduit	•			
INSTRUCTIONS FOR USE				
Use & Care Manual / Installation Manual	English / French / Spanish			