



Storage drawer 15

FD 150 BK



- Black Glass finish
- 15 cm high front panel
- Push-to-open system
- Telescopic rails
- Anti-slip rubber mat

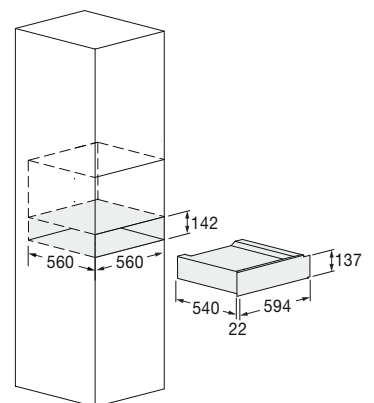

Features

This product comes with the following accessories: telescopic rails and an anti-slip rubber mat. Moreover, it can be combined with Fulgor Milano's products from the 60 cm range



BLACK GLASS
FD 150 BK
EAN 8019801031450

DRAWERS

STORAGE DRAWER 15



FD 150 BK		
Finish	Black Glass	
Type	Type: storage drawer	Anti-slip rubber bottom
Push-to-open door	•	
DIMENSIONS		
	Product (W x H x D) 594 x 137 x 562 mm	Built-In Cut Out (W x H x D) 560 x 142 x 560 mm