



Vacuum sealing drawer 15

FVSD 150 TC WH



- White Glass finish
- Touch control panel
- Push-to-open system
- Sealing bar (bags)
- Glass lid
- Stainless steel vacuum chamber
- Energy-saving function
- Chef function
- Vacuum cycle for storage + Vacuum cycle for cooking
- Pump oil dehumidification cycle
- Draw capacity volume 6.4 l

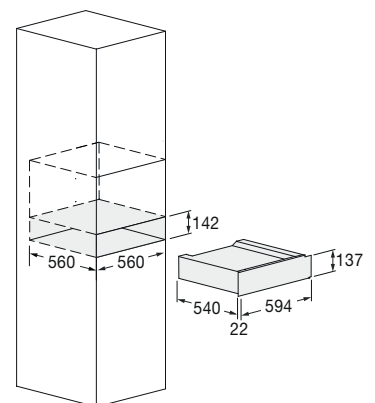

Features

Thanks to specific bags, the vacuum sealing drawer allows you to use the sous-vide technique to cook your recipes. This low-temperature technique cooks food homogeneously without dispersing its natural moisture. This appliance is fitted with the Chef function for marinating, ripening, and cold infusion processes. Moreover, it's ideal for massaging fish and meat and preparing sauces, gravies and concentrates. The drawer runs vacuum cycles in containers and short or long vacuum cycles outside the draw container.

This product can be combined with other appliances from the 45 cm and 60 cm range.



WHITE GLASS
FVSD 150 TC WH
EAN 8019801019946

DRAWER

VACUUM SEALING DRAWER 15



FVSD 150 TC WH		
Front finish	White Glass	
Type / Interiors: enamelled other	Vacuum sealing drawer / Stainless steel	
FEATURES		
	Push-to-open system	Programming Touch controls 4 total functions
	Max vacuum level 2 - 10 mbar (99.9%)	Container volume 6.4 l Max bag size 25 x 35 cm
	Chamber height 95 mm 65° degrees lid opening	Removable sealing bar (length 260 mm)
	CHEF cycle	Cooking cycle duration: 55"
	3 storage cycles duration 70"	Vacuum cycle in container
	Oil replacement indicator	Oil de-humidification cycle
POWER RATING		
	Max electrical power 230 W	Voltage / Frequency (V - Hz) 230 - 50 / 60
	Power cord	Plug (Schuko)
DIMENSIONS		
	Product (W x H x D) 594 x 137 x 562 mm	Built-In Cut Out (W x H x D) 560 x 142 x 560 mm