



Warming drawer 15

FWD 150 X



- Stainless steel finish
- 15 cm high front panel
- Push-to-open system
- Fully removable
- Ventilated
- Warm food function
- Defrosting
- Leavening
- Slow cooking up to 70 °C
- Dishes and coffee cups pre-heating

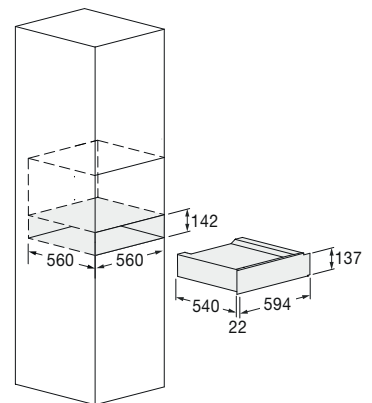

Features

The drawer features internal ventilation, an adjustable thermostat (from 30 °C to 70 °C) and an operation indicator light. This appliance comes with an anti-slip rubber mat. Moreover, it can be combined with other products from the 45 cm and 60 cm range



STAINLESS STEEL
FWD 150 X
EAN 8019801031801

DRAWER

WARMING DRAWER 15



FWD 150 X		
Finish	Stainless Steel	
Type / Interiors: enamelled / other	Warming drawer / Anti-slip rubber bottom	
PERFORMANCE		
	Maximum temperature 70 °C	Low-temperature cooking (slow cooking)
	Leavening	Plates and dish heating
CONTROLS		
	On/off key	Thermostat 30 °C - 70 °C
	Internal ventilation	Operation indicator
	Push-to-open door	Dark front panel
POWER RATING		
	Max power absorbed 400 W	Power supply (V - Hz) 220 - 240 V; 50-60 Hz
	Power cord	Plug (Schuko)
DIMENSIONS		
	Product (W x H x D) 594 x 137 x 562 mm	Built-In Cut Out (W x H x D) 560 x 142 x 560 mm