



Warming drawer 27

FWD 3024 X



- Manual controls
- 27 cm high front panel
- Internal capacity: 60 litres
- Push-to-open system
- Plates and cups heating
- Warm food function
- Defrosting
- Leavening
- Slow cooking up to 85 °C
- Telescopic rails

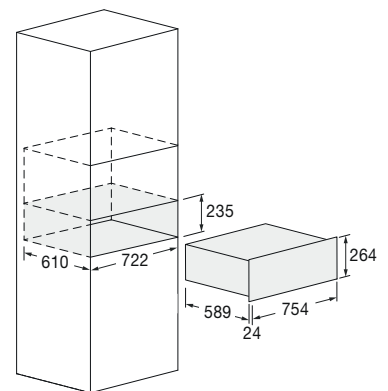

Features

The drawer features internal ventilation, an adjustable thermostat (from 30 °C to 85 °C) and two lights. This appliance comes with an anti-slip rubber mat. This product can be combined with other products from the 45 cm and 60 cm range.

Technical data

page 321



STAINLESS STEEL
FWD 3024 X
EAN 8019801031214

DRAWERS

WARMING DRAWER 27



FWD 3024 X		
	Type: warming drawer / Stainless Steel finish	Anti-slip rubber bottom
	Push-to-open door	It can be combined with oven mod. DCPO 315 P TEM 2F X
PERFORMANCE		
	Maximum temperature 85 °C	Low-temperature cooking (slow cooking)
	Leavening	Warm food function
CONTROLS		
	On/off key	Thermostat 30 °C - 85 °C
	Internal ventilation Operation indicator	Dark front panel
POWER RATING		
	Max power absorbed 1100 W	Power supply (V - Hz) 220 - 240 V; 50 - 60 Hz
	Power cord	Plug (Schuko)
DIMENSIONS		
Product (W x H x D) mm	Product (W x H x D) 754 x 264 x 613 mm	Built-In Cut Out (W x H x D) 722 x 235 x 610 mm