



Microwave oven 75x45

FCLMO 7510 TEM BK



- Deep Black finish
- 10 Combined Functions
- AirFry (oven-frying) function
- Creative Extended controls
- Automatic Cooking
- Microwave with 6 power levels
- Microwave & ventilation
- Microwave & grill
- Defrosting
- 3-pane glass cool-touch door

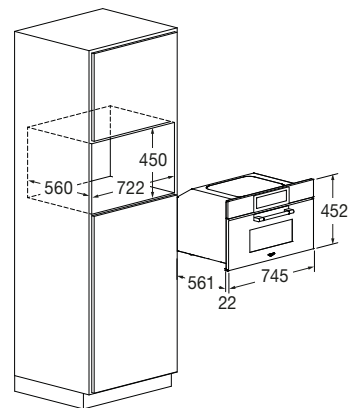

Features

The control panel has different functions, including preset cooking functions and the possibility to modify the recipes. Fulgor Milano combi oven is the solution to heat and cook food quickly, combining the advantages of a microwave oven with a traditional ventilated one. A complete and performing household appliance in a small space. With the microwave & ventilation function, you can cook golden brown dishes on the outside and well-cooked on the inside in no time. This product comes with the following accessories: a glass turntable plate, a stainless steel tray, a flat grill rack and a round grill rack.



DEEP BLACK GLASS
FCLMO 7510 TEM BK
EAN 8019801031986

CLUSTER

MICROWAVE OVEN 75X45



FCLMO 7510 TEM BK	
Type	Combined Microwave
Finish / Interiors: enamelled - other	Deep Black / Stainless steel
FEATURES	
Efficiency class	-
Capacity (litres)	34 L
Forced cooling	•
Functions no.	10
PERFORMANCE	
Max cooking temperature	230° C
Pre-loaded and editable recipes	•
AirFry (oven-frying)	•
Steam cooking 100° C / 130° C	- / -
Assisted cooking 100 °C	-
Mixed steam / convection	-
Defrosting (time/weight)	•
Assisted cleaning (CLEAN)	-
Microwave / Grill	•
Microwave / Convection	•
Microwave power (W)	900 W
Microwave power levels	6
Grill power (W)	1500 W
CONTROLS	
Control type	Creactive Extended
Easy Access	•
On/off icon	•
Forced cooling	•
Electronic temperature regulation	•
Internal light	•
SAFETY	
Safe door / no. of glass panes	• / 3
ACCESSORIES	
Lighting (Halogen, 25 W) no.	1
S.Steel Gastronorm Tray	•
Standard Flat Grill Rack	•
Glass turntable plate	•
Round Grill Rack	•
POWER RATING	
Max electrical power (W)	3200 W
Voltage / Frequency (V - Hz)	220 - 240 V; 50 Hz
Power cord	•
Plug	Schuko
DIMENSIONS	
Width (mm)	745
Height (mm)	452
Depth (mm)	561
Built-In Cut Out (W x H x D) mm	722 x 450 x 560