

OVEN 700 SERIES 30"









CODE ID

30" TOUCH CONTROL DOUBLE OVEN - STAINLESS STEEL

F7DP30S1



-  **CREACTIVE COOKING SYSTEM**
-  **PIZZA COOKING MODE 590 °F**
-  Dual Convection
-  Self Clean Oven
-  Multi-level cooking
-  1 Telescopic Rack per oven
-  Cool Touch Door
-  TFT Display
-  Meat Probe
-  Fast Pre-Heat
-  Interior Lighting

OVENS

Creative Touch Control System
Dual True Convection
Self-cleaning oven with Multifunction baking
Black Porcelain enamel interior
Cool to the touch
Extra-large baking cavity and viewing area
3 Halogen lights for flawless visibility
Total capacity 123 lt
Total capacity 4,34 cu. ft.
2 chromed racks
1 telescopic rack per oven
Enameled Broiler Pan
Lock Keys
Door Lock

OVEN FUNCTIONS

Bake (cooking group)
Broil
Convection (cooking group)
Keep Warm (cooking group)
Recipes
Classic Pizza Function 590°F
Preset default temperature
Preheat (display instantaneous temperature)
Fast Preheat Mode
Sabbath Mode
Setting Temperature °C/°F
Setting Weight Kg/lb
Event Logs (for Service)
Meat Probe (only upper oven)
Self-Clean

OPTIONAL ACCESSORIES

FMTR630 30" Telesc. Rack

SOFIA

30" TOUCH CONTROL DOUBLE OVEN

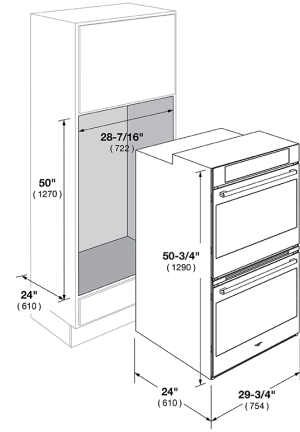

CODE ID	30" TOUCH CONTROL DOUBLE OVEN F7DP30S1	
Series	700	
Finish	Stainless Steel	
CONTROL PANEL		
Control Type	Creative Electronic Touch Control	
Display: Clock - Temperature - Function	TFT 3.5"	
Language	English (USA) / English (UK) / French / Spanish / Italian / German	
	Control Interface	Chime Volume Setting
	Full Touch: Functions - Recipes - Settings Menu	Date Format
	Brightness Setting	Demo Mode
OVEN		
Type	Dual True Convection	
Temperature Regulation	Electronic Control (min/max 170/550°F - 75/290°C)	
OVEN FUNCTIONS		
	Pyrolytic Self-Clean	Broil
	True Convection	Dehydrate
	Convection Broil	Thaw (Defrost)
	Convection Roast	Proof (Warm)
	Pizza (Lower Convection)	Keep warm (Warm Plus)
	Bake	Oven Lights
ELECTRIC OVEN FEATURES		
	Preset default temperature	Display instantaneous temperature
	Child Door Lock	Control Display Lock
	Sabbath Mode	12/24 Hour Clock Formats
	Automatic Fast Preheat	Temperature Display °C/°F
	Meat Probe (Upper Oven Only)	Event Logs (for Service)
OVEN DOOR(S)		
Oven Glass Window	Large See Through Glass	
Door Cooling System	4 Heat Resistant Glasses	
Door Hinges	Heavy Duty Steady Tilt	
OVEN CAVITY		
Total Capacity (lt)	123	
Total Capacity (cu. ft.)	4,34	
Cavity Enamel Colour	Black	
Rack Positions	6	
Oven Lights	3x20W Halogen	
HEATING ELEMENTS (@240V)		
Broil Upper Heating Element	3500 W	
Upper Auxiliary Element	1032 W	
Concealed Bake Lower Heating Element	3000 W	
Convection Element	2 x 1300 W	
OVEN ACCESSORIES		
Chromed Racks	2	
Enameled Broiler Pan (basin + anti splash)	1	
Telescopic Chromed Rack	1	
DIMENSIONS/WEIGHT		
Overall dim - Width	29 - 11/16"	(754 mm)
Overall dim - Height	50 - 13/16"	(1290 mm)
Overall dim - Depth	24"	(610 mm)
Cut-out - Width	28 - 7/16"	(722 mm)
Cut-out - Height (min)	50"	(1270 mm)
Cut-out - Depth (min)	23 - 1/4"	(590 mm)
Gross Weight	326 lbs	(148 kg)
POWER / RATINGS (208/240 V, 60 HZ)		
kW / Amps rating at 120-240V, 60Hz	7.50kW - 31.2A	
kW / Amps rating at 120-208V, 60Hz	6.30kW - 30.3A	
Power Cable	Conduit	
INSTRUCTIONS FOR USE		
Use & Care Manual / Installation Manual	English / French / Spanish	