



Steam oven 75x45

FCLSO 7510 TEM BK



- Deep Black finish
- 11 functions
- AirFry (oven-frying) function
- Creative Extended controls
- Meat probe
- Steam cooking
- Combined cooking
- Steam recovery cycle
- CLEAN assisted cleaning cycle
- 3-pane glass cool-touch door
- Energy Class A++

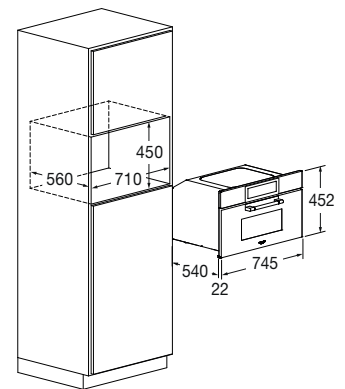

Features

The control panel has different functions, including preset cooking functions and the possibility to modify the recipes. With the Meat Probe, you can obtain perfect results because it allows you to monitor the cooking progress by measuring the food core temperature.

This product comes with the following accessories: a meat probe, a perforated tray with lid, a stainless steel support for perforated tray, a stainless steel tray, a flat grill rack and a water tank.



DEEP BLACK GLASS
FCLSO 7510 TEM BK
EAN 8019801031979

CLUSTER

STEAM OVEN 75X45



FCLSO 7510 TEM BK	
Type	Combined Steam
Finish / Interiors: enamelled - other	Deep Black / Stainless steel
FEATURES	
Efficiency class	A ++
Capacity (litres)	34 L
Forced cooling	•
Functions no.	11
PERFORMANCE	
Max cooking temperature	230° C
Pre-loaded and editable recipes	•
AirFry (oven-frying)	•
Steam cooking 100° C / 130° C	• / •
Assisted cooking 100 °C	•
Mixed steam / convection	•
Defrosting (time/weight)	-
Assisted cleaning (CLEAN)	•
Microwave / Grill	-
Microwave / Convection	-
Microwave power (W)	-
Grill power (W)	1500 W
CONTROLS	
Control type	Creactive Extended
Easy Access	•
Meat probe	•
On/off icon	•
Forced cooling	•
Electronic temperature regulation	•
Internal light	•
SAFETY	
Safe door / no. of glass panes	• / 3
ACCESSORIES	
Lighting (Halogen, 25 W) no.	1
Removable Water Tank	•
S.Steel Gastronorm Tray	•
Standard Flat Grill Rack / removable no.	1 / 1
S.Steel Perforated Tray with Lid	•
POWER RATING	
Max electrical power (W)	3200 W
Voltage / Frequency (V - Hz)	220 - 240 V; 50 Hz
Power cord	•
Plug	Schuko
DIMENSIONS	
Width (mm)	745
Height (mm)	452
Depth (mm)	561
Built-In Cut Out (W x H x D) mm	710 x 450 x 560