



Warming drawer 15

FWD 150 WH



- White Glass finish
- 15 cm high front panel
- Push-to-open system
- Fully removable
- Ventilated
- Warm food function
- Defrosting
- Leavening
- Slow cooking up to 70 °C
- Dishes and coffee cups pre-heating

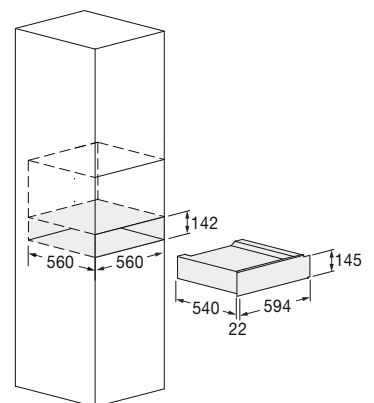

Features

The drawer features internal ventilation, an adjustable thermostat (from 30 °C to 70 °C) and an operation indicator light. This appliance comes with an anti-slip rubber mat. Moreover, it can be combined with other products from the 45 cm and 60 cm range



WHITE GLASS
FWD 150 WH
EAN 8019801031443

DRAWER

WARMING DRAWER 15



FWD 150 WH		
Finish	White Glass	
Type / Interiors: enamelled / other	Warming drawer / Anti-slip rubber bottom	
PERFORMANCE		
	Maximum temperature 70 °C	Low-temperature cooking (slow cooking)
	Leavening	Plates and dish heating
CONTROLS		
	On/off key	Thermostat 30 °C - 70 °C
	Internal ventilation	Operation indicator
	Push-to-open door	Dark front panel
POWER RATING		
	Max power absorbed 400 W	Power supply (V - Hz) 220 - 240 V; 50-60 Hz
	Power cord	Plug (Schuko)
DIMENSIONS		
	Product (W x H x D) 594 x 145 x 562 mm	Built-In Cut Out (W x H x D) 560 x 142 x 560 mm